

RoHS

REV.	LOCAS.	DESCRIPTION	DRAW.	DATE.
01	NEW	INITIAL RELEASE.	Liman.li	2016.03.09

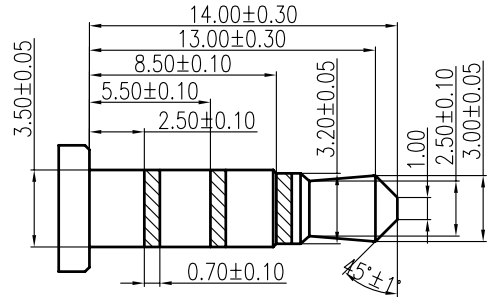

PLUG SPEC

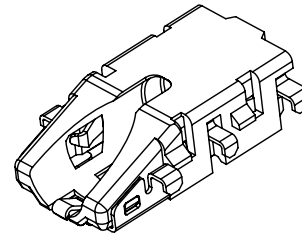

受控文件
2016.03.21
文控中心

SCHEMATIC

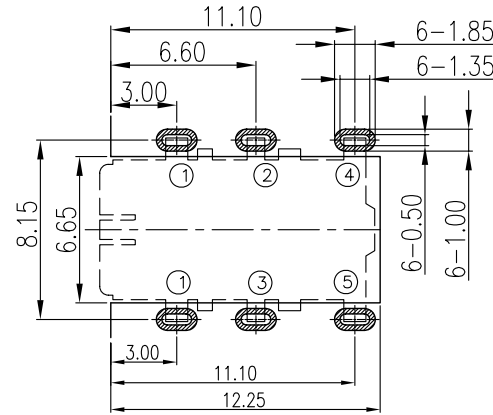
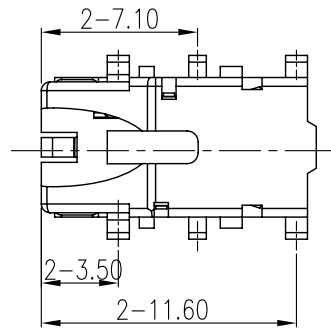
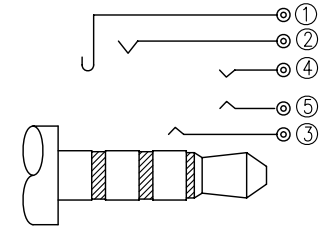

RECOMMEND PCB LAYOUT TOLERANCE :±0.05

TOP View

NOTES:

- MATERIAL:SEE TABLE
- SPECIALITY:
 - RATED CURRENT:1.0A
 - RATED VOLTAGE:12V
 - CONTACT RESISTANCE:30mΩ MAX
AFTER LIFT TEST:50mΩ MAX
 - INSULATION RESISTANCE:100MΩ MIN 500V DC
 - DIELECTRIC WITHSTANDING VOLTAGE: 500V AC.
 - SOLDER ABILITY:245±5°C, 5±0.5S.
 - DURABILITY:5000 CYCLES MIN.
 - OPERATING CONDITION:TEMPERATURE-30°C~+80°C;
HUMIDITY 80% R.H MAX
- MECHANICAL:
 - Insertion Force: 30N Max.
 - Extraction Force: 3N Min.
- PLEASE CONTACT JITS SALES REPRESENTATIVE TO VERIFY PRODUCTDETAILS & AVAILABILITY

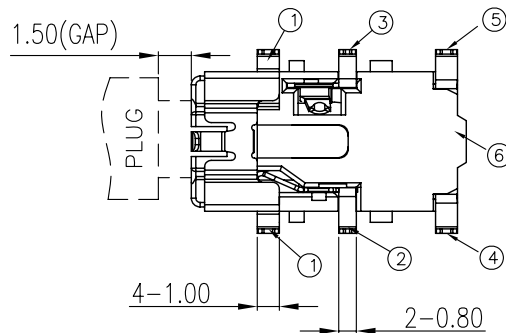
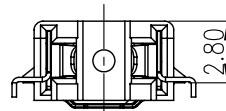
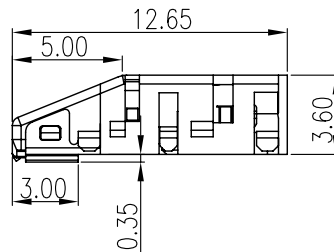
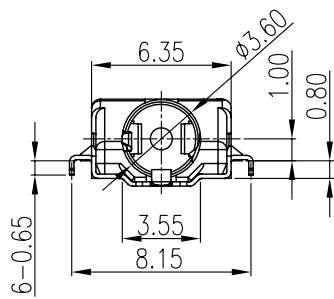

TABLE:

NO	Description	Dosage	Material	Color/solder
6	Housing	1PC	HIGH TEMPERATURE THERMOPLASTIC	BLACK
5	Termiral 5	1PC	Stainless Steel,T=0.20	Contact Au: 3u",solder Au:1u",Ni:60u" min
4	Termiral 4	1PC	Stainless Steel,T=0.20	Contact Au: 3u",solder Au:1u",Ni:60u" min
3	Termiral 3	1PC	Copper Alloy,T=0.20	Contact Au: 3u",solder Au:1u",Ni:60u" min
2	Termiral 2	1PC	Copper Alloy,T=0.20	Contact Au: 3u",solder Au:1u",Ni:60u" min
1	Termiral 1	1PC	Copper Alloy,T=0.20	Contact Au: 3u",solder Au: G/F,Ni:60u" min

MEASURE POINT: (QP)
QUADRANT POINT (QP)
TANGENCY POINT (TP)
INTERSECTION POINT (IP)

UNLESS OTHERWISE SPECIFIED, TOLERANCE:
X. ±0.25
X.X ±0.20
X.XX ±0.15
ANGULAR ±3°



DESING	DATE	TITLE: Ø3.5 PHONE JACK 3.6H,5P,STD,SUBSIDE0.8		
CHECKED	DATE			
APPROVED	DATE			
PART NO: DA280-K4-06A	REV: 01	SCALE: 1:1	UNIT: mm	
DRAWING NO: DA280-K4-06A	SIZE: A4	SHEET: 1/2		

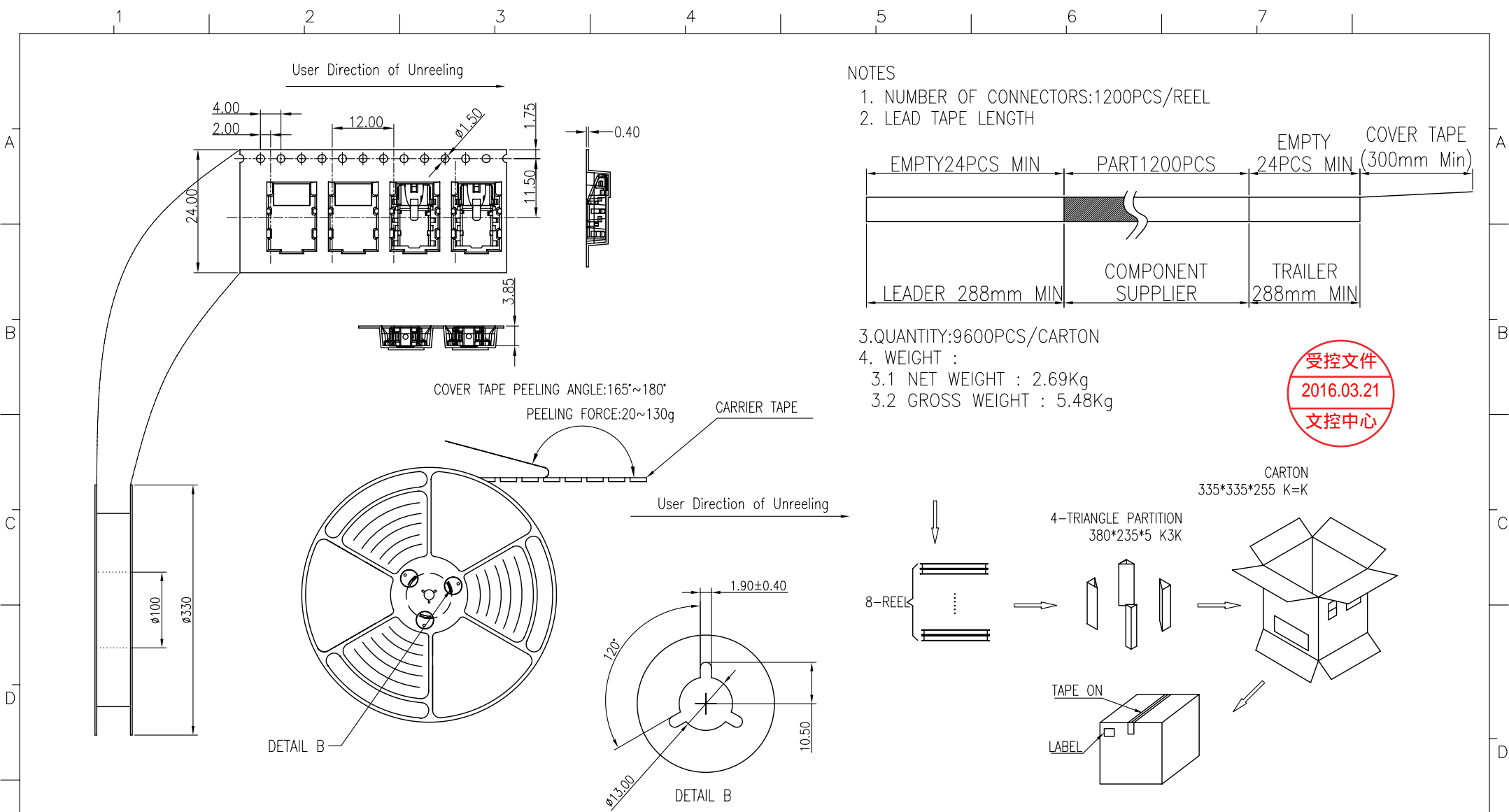

NOTES

- 1. NUMBER OF CONNECTORS:1200PCS/REEL
- 2. LEAD TAPE LENGTH
- 3. QUANTITY:9600PCS/CARTON
- 4. WEIGHT :
 - 3.1 NET WEIGHT : 2.69Kg
 - 3.2 GROSS WEIGHT : 5.48Kg



MEASURE POINT: QUADRANT POINT (QP) TANGENCY POINT (TP) INTERSECTION POINT (IP)			
	UNLESS OTHERWISE SPECIFIED, TOLERANCE: X. ±0.25 X.X ±0.20 X.XX ±0.15 ANGULAR ±3°		
DESING	DATE	TITLE:	
CHECKED	DATE	Ø3.5 PHONE JACK	
APPROVED	DATE	3.6H,5P,STD,SUBSIDE0.8	
PART NO: DA280-K4-06A		REV: 1	SCALE: 1:1
DRAWING NO: DA280-K4-06A		UNIT: mm	SHEET: 2/2