

RoHS

REV.	LOCAS.	DESCRIPTION	DRAW.	DATE.
01	NEW	INITIAL RELEASE.	Ann	2014. 10. 10
02	△	Update the drawing frame	Ann	2016. 01. 09

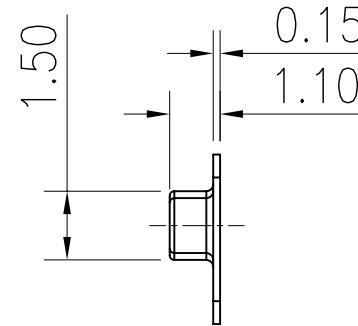

受控文件
 2016.03.24
 文控中心

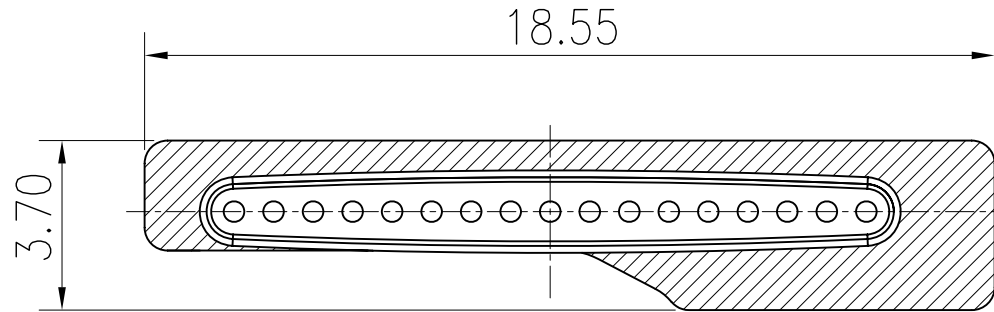
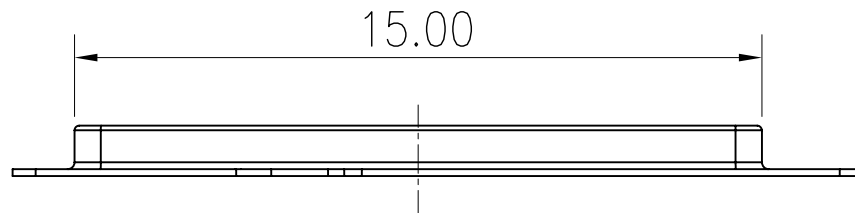

NOTES:
 MATERIAL:Stainless Steel. T=0.15mm.
 Minimum-Value Aperture:φ0.45mm.
 Pitch-Row:0.86mm; Hole Count:17 Pcs.

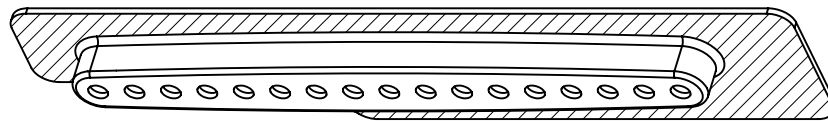

MEASURE POINT:
 QUADRANT POINT (QP)
 TANGENCY POINT (TP)
 INTERSECTION POINT (IP)

UNLESS OTHERWISE SPECIFIED, TOLERANCE:
 X. ±0.25
 X.x ±0.20
 X.xx ±0.15
 ANGULAR ±3°

JTS

JITS TECHNOLOGY CO., LIMITED

DESING	DATE	TITLE: DUST HELMET T=0.15*18.55*3.70 H=1.10mm φ=0.45mm		
CHECKED	DATE			
APPROVED	DATE			
PART NO: EAJS-M000	REV: 02	SCALE: 1:1	UNIT: mm	
DRAWING NO: EAJS-M000	SIZE: A4	SHEET: 1/2		

RoHS



DUST
HELMET

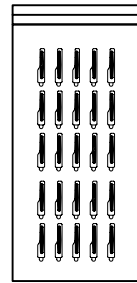

PC FLAKE AND PET FILM

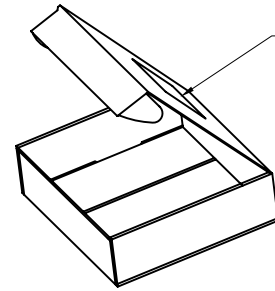

LABEL

BOX

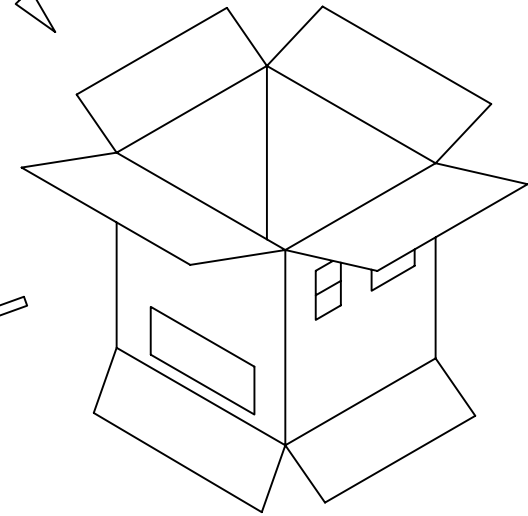
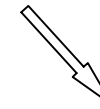

BOX

ADHESIVE TAPE

LABEL

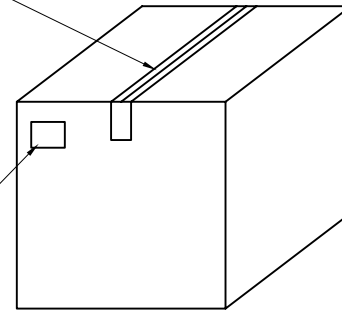

TABLE

	SPEC	QTY
SMALL PACKING	PET膜 T0.1*70mm	0.2M/20PCS
	纸盒 150*150*40mm	1/1200PCS
LARGE PACKING	外纸箱 342*342*250 K=K 有LOGO	1/24KPCS

MEASURE POINT:

QUADRANT POINT (QP)
TANGENCY POINT (TP)
INTERSECTION POINT (IP)

UNLESS OTHERWISE
SPECIFIED, TOLERANCE:

X. ±0.25
X.x ±0.20
X.xx ±0.15
ANGULAR ±3°

JTS JITS
TECHNOLOGY CO., LIMITED

DESING	DATE	TITLE:		
CHECKED	DATE	DUST HELMET T=0.15*18.55*3.70		
APPROVED	DATE	H=1.10mm φ=0.45mm		
PART NO: EAJS-M000	REV: 02	SCALE: 1:1	UNIT: mm	
DRAWING NO: EAJS-M000	SIZE: A4	SHEET: 2/2		